

DV910

# Oxford





DIREZIONALI - EXECUTIVES - DIRECTION - EJECUTIVAS

DV910 OXFORD  
DV914 DAKAR  
DV902 PLANETA  
DV901 VERTIGO  
DV905 RYM  
DV911 NOTO  
DV913 VIGO

**LEGENDA**

LEGEND  
LÉGENDE  
LEYENDA

 **Con serratura**  
With lock  
Avec serrure  
Con cerradura

 **Articolo non in pronta consegna. Per la disponibilità contattare l'ufficio commerciale**  
Item not in prompt delivery. Please contact the sales department for checking availability.  
Article pas disponible en stock. Merci de contacter le service commercial pour vérifier la disponibilité.  
Producto no disponible en stock. Para la disponibilidad contactar con el departamento comercial.

 **Presà per mercato EU**  
EU power outlet  
Prise électrique EU  
Toma eléctrica EU

 **Presà per mercato UK**  
UK power outlet  
Prise électrique UK  
Toma eléctrica UK

 **Presà per mercato US**  
US power outlet  
Prise électrique US  
Toma eléctrica US

 **Dimensioni espresse in centimetri**  
Dimensions expressed in centimetres  
Dimensions exprimées en centimètres  
Dimensiones expresadas en centímetros

**CERTIFICAZIONI**  
CERTIFICATIONS  
CERTIFICATIONS  
CERTIFICACIONES



**GARANZIE**  
WARRANTIES  
GARANTIES  
GARANTÍAS



**CARATTERISTICHE**  
**FEATURES**  
**CARACTÉRISTIQUES**  
**CARACTERISTICAS**



**Scrivanìa con piano scorrevole - apertura 8 cm**  
 Desk with sliding top - opening 8 cm  
 Bureau avec plateau coulissant - ouverture 8 cm  
 Mesa con sobre deslizante - apertura 8 cm

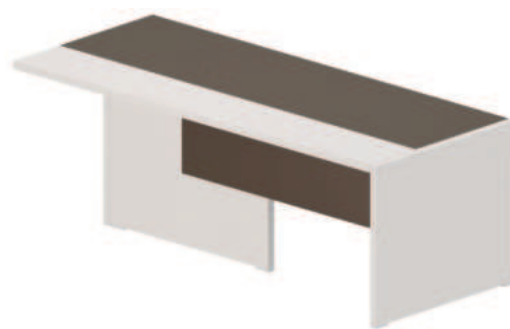

**Piano operatore e modesty panel in melaminico finitura effetto pelle (variante M3)**  
 Operator worktop and modesty panel in leather-effect finish melamine (M3 variant)  
 Plateau opérateur et voile de fond en mélamine finition effet cuir (variante M3)  
 Sobre de operador y panel frontal en melamina efecto cuero (variante M3)



**Piano di lavoro e gambe realizzati in conglomerato ligneo sp. 38 mm**  
 Worktop and legs made of 38 mm th. wood conglomerate  
 Plateau et pieds panneaux en mélamine ép. 38 mm  
 Sobre de trabajo y patas realizados en madera aglomerada de 38 mm de espesor

**Scrivanìa con altezza regolabile 75 ÷ 141 cm**  
 Height-adjustable desk from 75 to 141 cm  
 Bureau réglable en hauteur de 75 à 141 cm  
 Mesa regulable en altura de 75 a 141 cm



**Tastierino per regolazione altezza piano con 4 memorie**  
 Control pad with 4 memories for height adjustable worktop  
 Clavier pour le réglage de la hauteur plateau avec 4 mémoires de positions  
 Unidad de control con 4 memorias para regulación altura sobre de trabajo

**Trave metallica telescopica canalizzata per il passaggio e l'alloggiamento dei cablaggi**  
 Telescopic metal beam ducted made with a shape to allow the wire management  
 Poutre métallique telescopique/goulotte qui permet son utilisation pour le passage et placement des câbles  
 Travesaño metálico telescópico canalizado que permite la utilización del mismo para el paso y el alojamiento de los cables

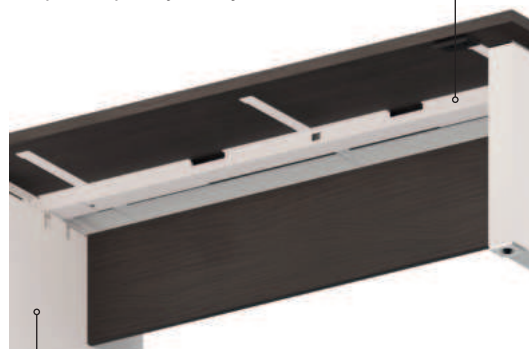

**Il meccanismo di regolazione è posizionato all'interno dei fusti**  
 The adjustment mechanism is positioned in the inner tubes  
 Le mécanisme de réglage est positionné à l'intérieur des futs  
 El mecanismo de regulación está ubicado en el interior de los tubos

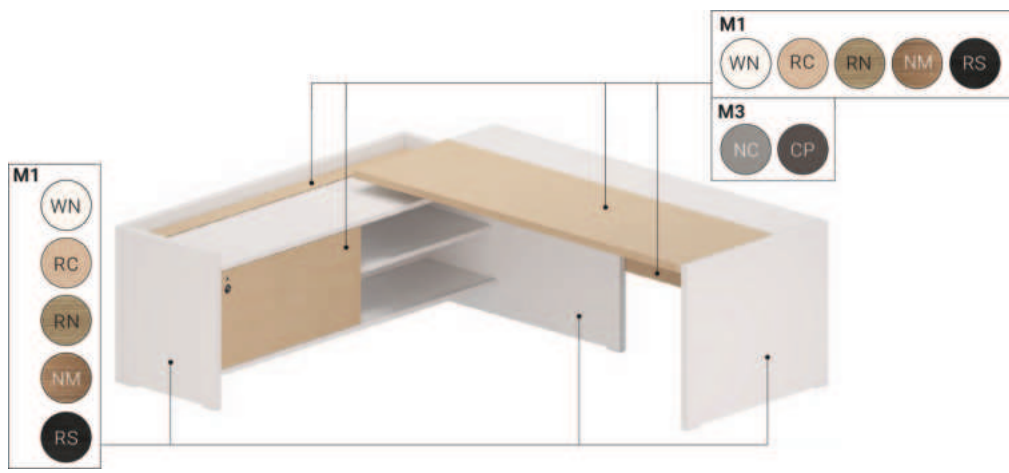
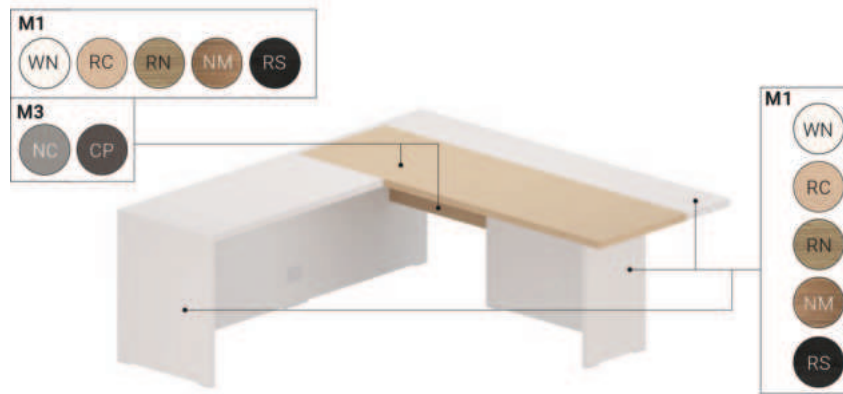

**V01**

**Piano operatore in melaminico sp. 38 mm** - 38 mm th. melamine user-side worktop - Plateau operateur en mélamine ép. 38 mm - Lado operador de melamina de 38 mm de esp.

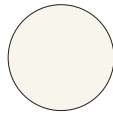
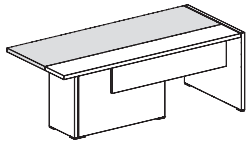

**WN**

Bianco  
White  
Blanc  
Blanco



**RC**

Rovere chiaro  
Light oak  
Chêne clair  
Roble claro



**RN**

Rovere naturale  
Natural oak  
Chêne naturel  
Roble natural



**NM**

Noce  
Walnut  
Noyer  
Nogal



**RS**

Rovere scuro  
Dark oak  
Chêne foncé  
Roble oscuro

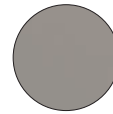

**NC**

Nocciola  
Hazelnut  
Noisette  
Avellana

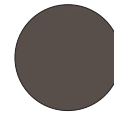

**CP**

Cappuccino  
Cappuccino  
Cappuccino  
Cappuccino

**V02**

**Piano visitatore in melaminico sp. 38 mm** - 38 mm th. melamine visitor-side worktop - Plateau visiteur en melamine ép. 38 mm - Sobre lado del visitante de melamina de 38 mm de esp.

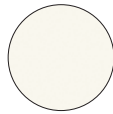
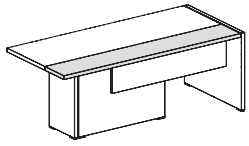

**WN**

Bianco  
White  
Blanc  
Blanco



**RC**

Rovere chiaro  
Light oak  
Chêne clair  
Roble claro



**RN**

Rovere naturale  
Natural oak  
Chêne naturel  
Roble natural



**NM**

Noce  
Walnut  
Noyer  
Nogal



**RS**

Rovere scuro  
Dark oak  
Chêne foncé  
Roble oscuro

**V02**

**Gambe pannellate in melaminico sp. 38 mm** - Melamine pannelled legs 38 mm th. - Pieds panneaux en melamine ép. 38 mm - Patas paneladas en melamina de esp. 38 mm

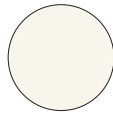
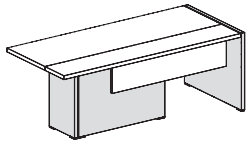

**WN**

Bianco  
White  
Blanc  
Blanco



**RC**

Rovere chiaro  
Light oak  
Chêne clair  
Roble claro



**RN**

Rovere naturale  
Natural oak  
Chêne naturel  
Roble natural



**NM**

Noce  
Walnut  
Noyer  
Nogal



**RS**

Rovere scuro  
Dark oak  
Chêne foncé  
Roble oscuro

**V01**

**Modesty panel sp. 25 mm** - Modesty panel 25 mm th. - Voile de fond ép. 25 mm - Faldón esp. 25 mm

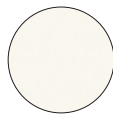
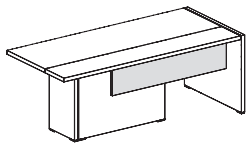

**WN**

Bianco  
White  
Blanc  
Blanco



**RC**

Rovere chiaro  
Light oak  
Chêne clair  
Roble claro



**RN**

Rovere naturale  
Natural oak  
Chêne naturel  
Roble natural



**NM**

Noce  
Walnut  
Noyer  
Nogal



**RS**

Rovere scuro  
Dark oak  
Chêne foncé  
Roble oscuro

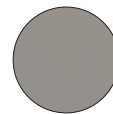

**NC**

Nocciola  
Hazelnut  
Noisette  
Avellana

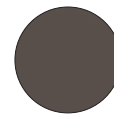

**CP**

Cappuccino  
Cappuccino  
Cappuccino  
Cappuccino

**FINITURE**  
FINISHES  
FINITIONS  
ACABADOS

**V02**

**Mobile di servizio: Scocca in melaminico sp. 25/38 mm - Ripiani in melaminico sp. 25 mm - Service cabinet: 25/38 mm th. melamine shell - 25 mm th. melamine shelves - Armoire de service : coque en mélamine de 25/38 mm d'épaisseur - étagères en mélamine de 25 mm d'épaisseur - Mueble auxiliar: estructura de melamina de 25/38 mm de esp. - Estantes de melamina de 25 mm de esp.**

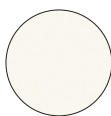
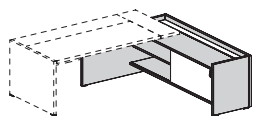

**WN**

Bianco  
White  
Blanc  
Blanco



**RC**

Rovere chiaro  
Light oak  
Chêne clair  
Roble claro



**RN**

Rovere naturale  
Natural oak  
Chêne naturel  
Roble natural



**NM**

Noce  
Walnut  
Noyer  
Nogal



**RS**

Rovere scuro  
Dark oak  
Chêne foncé  
Roble oscuro

**V01**

**Mobile di servizio: Ante sp.18 mm bordate in ABS - Service cabinet: 18mm th. doors edged in ABS perimeter - Armoire de service : portes de 18 mm d'épaisseur bordées d'un périmètre en ABS - Mueble auxiliar: puertas de 18 mm de esp. con cantos en ABS**

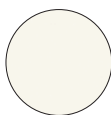
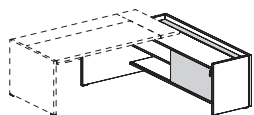

**WN**

Bianco  
White  
Blanc  
Blanco



**RC**

Rovere chiaro  
Light oak  
Chêne clair  
Roble claro



**RN**

Rovere naturale  
Natural oak  
Chêne naturel  
Roble natural



**NM**

Noce  
Walnut  
Noyer  
Nogal



**RS**

Rovere scuro  
Dark oak  
Chêne foncé  
Roble oscuro

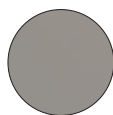

**NC**

Nocciola  
Hazelnut  
Noisette  
Avellana

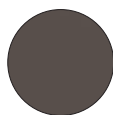

**CP**

Cappuccino  
Cappuccino  
Cappuccino  
Cappuccino

**V02**

**Colonne per regolazione in altezza, da un minimo di 64,5 cm ad un massimo di 130 cm - Columns for height adjustment, from a minimum of 64,5 cm to a maximum of 130 cm - Colonne réglables en hauteur, d'un minimum de 64,5 cm à un maximum de 130 cm - Columnas para regulación de altura, de un mínimo de 64,5 cm a un máximo de 130 cm**

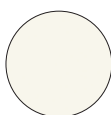
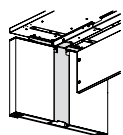

**W**

(RAL 9016)  
Bianco  
White  
Blanc  
Blanco

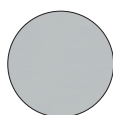

**H**

(RAL 9006)  
Alluminio  
Aluminium  
Aluminium  
Aluminio



**A**

(RAL 7016)  
Antracite  
Anthracite  
Anthracite  
Antracita

**Tastierino per regolazione altezza piano con 4 memorie - Control pad with 4 memories for height adjustable worktop - Clavier pour le réglage de la hauteur plateau avec 4 mémoires de positions - Unidad de control con 4 memorias para regulación altura sobre de trabajo**



**V19**

**Alimentazione elettrica - Power supply - Alimentation électrique - Alimentación eléctrica**

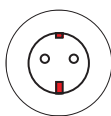

**EU**

Presa mercato EU  
EU power outlet  
Prise électrique EU  
Toma eléctrica EU

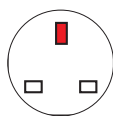

**UK**

Presa mercato UK  
UK power outlet  
Prise électrique UK  
Toma eléctrica UK



**US**

Presa mercato US  
US power outlet  
Prise électrique US  
Toma eléctrica US

**FINITURE**  
FINISHES  
FINITIONS  
ACABADOS

**V04**

**Mobile multifunzione: Scocche in melaminico sp. 38 mm** - Multifunctional cabinet: 38 mm th. melamine shells - Armoire multifonctionnelle : structure en mélamine ép. 38 mm - Mueble multifuncional: estructura de melamina 38 mm de esp.

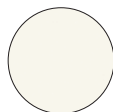
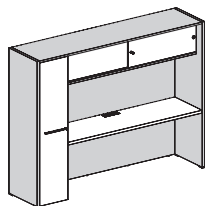

**WN**

Bianco  
White  
Blanc  
Blanco



**RC**

Rovere chiaro  
Light oak  
Chêne clair  
Roble claro



**RN**

Rovere naturale  
Natural oak  
Chêne naturel  
Roble natural



**NM**

Noce  
Walnut  
Noyer  
Nogal



**RS**

Rovere scuro  
Dark oak  
Chêne foncé  
Roble oscuro

**V01**

**Mobile multifunzione: Ante in melaminico sp. 18 mm / Piani in melaminico sp. 38 mm** - Multifunction cabinet: 18 mm th. melamine doors / 38 mm th. melamine worktops - Armoire multifonctionnelle : portes en mélamine de 18 mm d'épaisseur / plans de travail en mélamine de 38 mm d'épaisseur - Armario multifuncional: puertas de melamina de 18 mm de esp. / encimeras de melamina de 38 mm de esp.

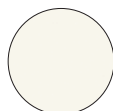
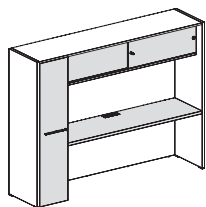

**WN**

Bianco  
White  
Blanc  
Blanco



**RC**

Rovere chiaro  
Light oak  
Chêne clair  
Roble claro



**RN**

Rovere naturale  
Natural oak  
Chêne naturel  
Roble natural



**NM**

Noce  
Walnut  
Noyer  
Nogal



**RS**

Rovere scuro  
Dark oak  
Chêne foncé  
Roble oscuro

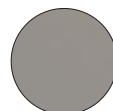

**NC**

Nocciola  
Hazelnut  
Noisette  
Avellana



**CP**

Cappuccino  
Cappuccino  
Cappuccino  
Cappuccino

**V06**

**Mobile multifunzione: Schiena puntinabile** - Multifunctional furniture: Pinnable backpanel - Meuble multifonctionnel : panneau punaisable - Mueble multifuncional: Trasera "pinnable"

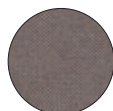
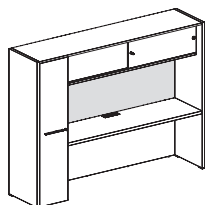

**JB9109**

Pepe  
Pepper  
Poivre  
Pimienta

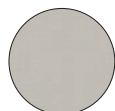

**JB9110**

Sesamo  
Sesame  
Sésame  
Sésamo



**JB9804**

Timo  
Thyme  
Thym  
Tomillo



**JB9806**

Liquirizia  
Licorice  
Régλισse  
Regaliz

**Rivestimento in poliester 100% Trevira CS Jet Bioactive**  
100% polyester coating Trevira CS Jet Bioactive  
Revêtement en 100% polyester Trevira CS Jet Bioactive  
Revestimiento de poliéster 100% Trevira CS Jet Bioactive

**FINITURE**  
FINISHES  
FINITIONS  
ACABADOS

**V01**

**Cassettiere: Frontali cassetti in melaminico sp. 18 mm** - Drawer cabinets: 18 mm th. melamine drawer fronts - Caissons : façades des tiroirs en mélamine ép. 18 mm - Cajoneras: frentes de cajón de melamina de 18 mm de esp.

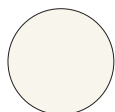

**WN**

Bianco  
White  
Blanc  
Blanco



**RC**

Rovere chiaro  
Light oak  
Chêne clair  
Roble claro



**RN**

Rovere naturale  
Natural oak  
Chêne naturel  
Roble natural



**NM**

Noce  
Walnut  
Noyer  
Nogal



**RS**

Rovere scuro  
Dark oak  
Chêne foncé  
Roble oscuro

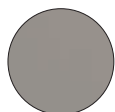

**NC**

Nocciola  
Hazelnut  
Noisette  
Avellana



**CP**

Cappuccino  
Cappuccino  
Cappuccino  
Cappuccino

**V04**

**Cassettiere: Fianchi di finitura in melaminico sp. 18 mm** - Drawer cabinets: 18 mm th. melamine finishing side panel - Caissons : Côté de finition en mélamine ép.18 mm - Cajoneras: lateral de acabado de melamina de 18 mm de esp.



**WN**

Bianco  
White  
Blanc  
Blanco



**RC**

Rovere chiaro  
Light oak  
Chêne clair  
Roble claro



**RN**

Rovere naturale  
Natural oak  
Chêne naturel  
Roble natural



**NM**

Noce  
Walnut  
Noyer  
Nogal



**RS**

Rovere scuro  
Dark oak  
Chêne foncé  
Roble oscuro

**V04**

**Cassettiere: Scocche in melaminico sp. 18 mm** - Drawer cabinets: 18 mm th. melamine body - Caissons : structure en mélamine ép.18 mm - Cajoneras: cuerpos de melamina de 18 mm de esp.

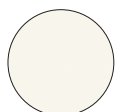

**WN**

Bianco  
White  
Blanc  
Blanco

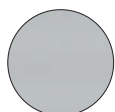

**HH**

Alluminio  
Aluminium  
Aluminium  
Aluminio

**Scocca WN per fianco di finitura WN / Scocca HH per fianco di finitura RC - RN - NM - RS - NC - CP**

WN body for finishing side panel WN / HH body for finishing side panel RC - RN - NM - RS - NC - CP

Structure WN pour côté de finition WN / HH structure pour côté de finition RC - RN - NM - RS - NC - CP

Cuerpo WN para lateral de acabado WN / Cuerpo HH para lateral de acabado RC - RN - NM - RS - NC - CP

**XBR**

**Maniglia** - Handle - Poignée - Tirador



Int. 96 mm - L. 106 mm  
Int. 256 mm - L. 266 mm  
Int. 512 mm - L. 522 mm



**AL**

Alluminio lucido  
Polished  
aluminium  
Aluminium brillant  
Aluminio brillante

**Int. 96 mm - L. 106 mm / Int. 256 mm - L. 266 mm / Int. 512 mm - L. 522 mm**

Int. 96 mm - W. 106 mm / Int. 256 mm - W. 266 mm / Int. 512 mm - W. 522 mm

Intérieur 96 mm - L. 106 mm / Intérieur 256 mm - L. 266 mm / Intérieur 512 mm - L. 522 mm

Interior 96 mm - Anch. 106 mm / Interior 256 mm - Anch. 266 mm / Interior 512 mm - Anch. 522 mm



# DV910 - Oxford

## M1

PIANO OPERATORE + MODESTY  
USER-SIDE WORKTOP + MODESTY  
PLATEAU UTILISATEUR + VDF  
SOBRE LADO OPERADOR + FALDÓN



## M3

VARIANTE: PIANO OPERATORE + MODESTY  
VARIANT: WORKTOP + MODESTY  
VARIANTE: PLATEAU UTILISATEUR + VDF  
VARIANTE: SOBRE LADO OPERADOR + FALDÓN



+ PIANO VISITATORE + GAMBE  
VISITOR-SIDE WORKTOP + LEGS  
PLATEAU VISITEUR + PIEDS  
SOBRE VISITANTE + PATAS



### Scrivania - Piano in melaminico sp. 38 mm

Desk - Melamine worktop th. 38 mm  
Bureau - Plateau en mélamine ép. 38 mm  
Mesa - Sobre de melamina esp. 38 mm

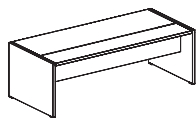

L. W.	P. D.	H. H.	CODICE CODE	M1	M3	Kg. lb	m <sup>3</sup> ft <sup>3</sup>	n. no.
184 72 1/2"	90 35 3/8"	75 29 1/2"	<b>910TS6818</b>			91,50 202.00	0,206 7.27	4 4
204 80 3/8"	90 35 3/8"	75 29 1/2"	<b>910TS6820</b>			96,50 213.00	0,220 7.77	4 4
224 88 1/4"	90 35 3/8"	75 29 1/2"	<b>910TS6822</b>			102,00 225.00	0,234 8.26	4 4

CANALE PASSACAVI  
CABLE DUCT  
PASSE-CÂBLES  
CANAL PASACABLES



### Canale passacavi singolo - Per scrivania

Single cable duct - For single desk  
Goulotte simple passe-câbles - Pour bureau individuel  
Canal pasacables individual - Para mesa individual



L.P. T.L.	L. W.	P. D.	H. H.	CODICE CODE	PRICE	Kg. lb	m <sup>3</sup> ft <sup>3</sup>	n. no.
184 72 1/2"	160 63"	10,2 4"	11,4 4 1/2"	<b>300AP2516</b>		2,50 5.51	0,010 0.35	1 1
204 - 224 80 3/8" - 88 1/4"	180 70 7/8"	10,2 4"	11,4 4 1/2"	<b>300AP2518</b>		2,80 6.17	0,012 0.42	1 1

# DV910 - Oxford

**M1**  
PIANO OPERATORE + MODESTY  
USER-SIDE WORKTOP + MODESTY  
PLATEAU UTILISATEUR + VDF  
SOBRE LADO OPERADOR + FALDÓN



**M3**  
VARIANTE: PIANO OPERATORE + MODESTY  
VARIANT: WORKTOP + MODESTY  
VARIANTE: PLATEAU UTILISATEUR + VDF  
VARIANTE: SOBRE LADO OPERADOR + FALDÓN



**+** PIANO VISITATORE + GAMBE  
VISITOR-SIDE WORKTOP + LEGS  
PLATEAU VISITEUR + PIEDS  
SOBRE VISITANTE + PATAS



## Scrivania - Indicare Dx o Sx

Desk - Specify R or L  
Bureau - Préciser D ou G  
Mesa - Indicar Dch o Izq

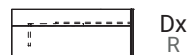
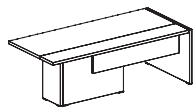

Dx  
R

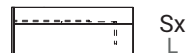

Sx  
L

	L. W.	P. D.	H. H.	CODICE CODE	M1	M3	Kg. lb	m <sup>3</sup> ft <sup>3</sup>	n. no.
	180 70 7/8"	90 35 3/8"	75 29 1/2"	<b>910TS5918</b>			96,46 213.00	0,221 7.80	7 7
	200 78 3/4"	90 35 3/8"	75 29 1/2"	<b>910TS5920</b>			100,16 221.00	0,238 8.40	7 7
	220 86 5/8"	90 35 3/8"	75 29 1/2"	<b>910TS5922</b>			106,16 234.00	0,248 8.76	7 7

CANALE PASSACAVI  
CABLE DUCT  
PASSE-CÂBLES  
CANAL PASACABLES



## Canale passacavi singolo - Per scrivania

Single cable duct - For single desk  
Goulotte simple passe-câbles - Pour bureau individuel  
Canal pasacables individual - Para mesa individual



	L.P. T.L.	L. W.	P. D.	H. H.	CODICE CODE	PRICE	Kg. lb	m <sup>3</sup> ft <sup>3</sup>	n. no.
	180 70 7/8"	120 47 1/4"	10,2 4"	11,4 4 1/2"	<b>300AP2512</b>		2,00 4.41	0,007 0.25	1 1
	200 78 3/4"	140 55 1/8"	10,2 4"	11,4 4 1/2"	<b>300AP2514</b>		2,20 4.85	0,009 0.32	1 1
	220 86 5/8"	160 63"	10,2 4"	11,4 4 1/2"	<b>300AP2516</b>		2,50 5.51	0,010 0.35	1 1

# DV910 - Oxford

## M1

PIANO OPERATORE + MODESTY  
USER-SIDE WORKTOP + MODESTY  
PLATEAU UTILISATEUR + VDF  
SOBRE LADO OPERADOR + FALDÓN



## M3

VARIANTE: PIANO OPERATORE + MODESTY  
VARIANT: WORKTOP + MODESTY  
VARIANTE: PLATEAU UTILISATEUR + VDF  
VARIANTE: SOBRE LADO OPERADOR + FALDÓN



PIANO VISITATORE + GAMBE + ALLUNGO  
VISITOR-SIDE WORKTOP + LEGS + RETURN  
PLATEAU VISITEUR + PIEDS + RETOUR  
SOBRE DEL VISITANTE + PATAS + ALARGO



### Scrivania con allungo H. 75 - Indicare Dx o Sx

Desk with extension H. 75 - Specify R or L  
Bureau avec retour Ht. 75 - Préciser D ou G  
Mesa con alargo H. 75 - Indicar Dch o Izq

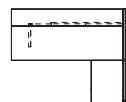
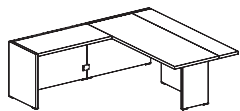

Dx  
R

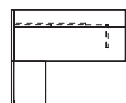

Sx  
L

L. W.	P. D.	H. H.	CODICE CODE	M1	M3	Kg. lb	m <sup>3</sup> ft <sup>3</sup>	n. no.
180 70 7/8"	210 82 5/8"	75 29 1/2"	910TM4718			151,90 335.00	0,343 12.10	12 12
200 78 3/4"	210 82 5/8"	75 29 1/2"	910TM4720			155,60 343.00	0,360 12.70	12 12
220 86 5/8"	210 82 5/8"	75 29 1/2"	910TM4722			161,60 356.00	0,370 13.10	12 12

CANALE PASSACAVI  
CABLE DUCT  
PASSE-CÂBLES  
CANAL PASACABLES



### Canale passacavi singolo - Per scrivania

Single cable duct - For single desk  
Goulotte simple passe-câbles - Pour bureau individuel  
Canal pasacables individual - Para mesa individual



L.P. T.L.	L. W.	P. D.	H. H.	CODICE CODE	PRICE	Kg. lb	m <sup>3</sup> ft <sup>3</sup>	n. no.
180 70 7/8"	120 47 1/4"	10,2 4"	11,4 4 1/2"	300AP2512		2,00 4.41	0,007 0.25	1 1
200 78 3/4"	140 55 1/8"	10,2 4"	11,4 4 1/2"	300AP2514		2,20 4.85	0,009 0.32	1 1
220 86 5/8"	160 63"	10,2 4"	11,4 4 1/2"	300AP2516		2,50 5.51	0,010 0.35	1 1

### Canale passacavi singolo - Per allungo

Single cable duct - For return  
Goulotte simple passe-câbles - Pour retour  
Canal pasacables individual - Para alargo



L.P. T.L.	L. W.	P. D.	H. H.	CODICE CODE	PRICE	Kg. lb	m <sup>3</sup> ft <sup>3</sup>	n. no.
120 47 1/4"	100 39 3/8"	10,2 4"	11,4 4 1/2"	300AP2510		1,90 4.19	0,006 0.21	1 1

# DV910 - Oxford

## M1

PIANO OPERATORE + MODESTY + ANTE  
 USER-SIDE WORKTOP + MODESTY + DOORS  
 PLATEAU UTILISATEUR + VDF + PORTES  
 SOBRE LADO OPERADOR + FALDÓN + PUERTAS



## M3

VARIANTE: PIANO OPERATORE + MODESTY + ANTE  
 VARIANT: WORKTOP + MODESTY + DOORS  
 VARIANTE: PLATEAU UTILISATEUR + VDF + PORTES  
 VARIANTE: PIANO DEL USUARIO + FALDÓN + PUERTAS



PIANO VISITATORE + GAMBE + MOBILE SERVIZIO  
 VISITOR-SIDE WORKTOP + LEGS + SERVICE UNIT  
 PLATEAU VISITEUR + PIEDS + MEUBLE DE SERVICE  
 SOBRE DEL VISITANTE + PATAS + MUEBLE AUXILIAR



### Scrivania con mobile di servizio H. 65 - Indicare Dx o Sx

Desk with service unit H. 65 - Specify R or L

Bureau avec meuble de service Ht. 65 - Préciser D ou G

Mesa con mueble auxiliar H. 65 - Indicar Dch o Izq

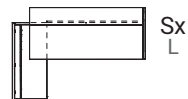
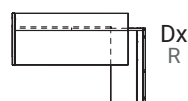
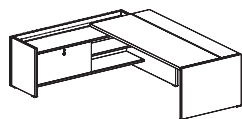

	L.P. T.L.	L. W.	P. D.	H. H.	CODICE CODE	M1	M3	Kg. lb	m <sup>3</sup> ft <sup>3</sup>	n. no.
FO	180 70 7/8"	210 82 5/8"	210 82 5/8"	75 29 1/2"	910TM3221			206,96 456.00	0,487 17.20	16 16
FO	200 78 3/4"	230 90 1/2"	210 82 5/8"	75 29 1/2"	910TM3223			210,66 464.00	0,503 17.80	16 16
FO	220 86 5/8"	250 98 3/8"	210 82 5/8"	75 29 1/2"	910TM3225			217,16 479.00	0,517 18.30	16 16

CANALE PASSACAVI  
 CABLE DUCT  
 PASSE-CÂBLES  
 CANAL PASACABLES



### Canale passacavi singolo - Per scrivania

Single cable duct - For single desk

Goulotte simple passe-câbles - Pour bureau individuel

Canal pasacables individual - Para mesa individual



	L.P. T.L.	L. W.	P. D.	H. H.	CODICE CODE	PRICE	Kg. lb	m <sup>3</sup> ft <sup>3</sup>	n. no.
	180 70 7/8"	120 47 1/4"	10,2 4"	11,4 4 1/2"	300AP2512		2,00 4.41	0,007 0.25	1 1
	200 78 3/4"	140 55 1/8"	10,2 4"	11,4 4 1/2"	300AP2514		2,20 4.85	0,009 0.32	1 1
	220 86 5/8"	160 63"	10,2 4"	11,4 4 1/2"	300AP2516		2,50 5.51	0,010 0.35	1 1

# DV910 - Oxford

## M1

PIANO OPERATORE + MODESTY + ANTE  
 USER-SIDE WORKTOP + MODESTY + DOORS  
 PLATEAU UTILISATEUR + VDF + PORTES  
 SOBRE LADO OPERADOR + FALDÓN + PUERTAS



## M3

VARIANTE: PIANO OPERATORE + MODESTY + ANTE  
 VARIANT: WORKTOP + MODESTY + DOORS  
 VARIANTE: PLATEAU UTILISATEUR + VDF + PORTES  
 VARIANTE: PIANO DEL USUARIO + FALDÓN + PUERTAS



PIANO VISITATORE + GAMBE + MOBILE SERVIZIO  
 VISITOR-SIDE WORKTOP + LEGS + SERVICE UNIT  
 PLATEAU VISITEUR + PIEDS + MEUBLE DE SERVICE  
 SOBRE DEL VISITANTE + PATAS + MUEBLE AUXILIAR



### Scrivania con piano sliding e mobile di servizio H. 65 - Indicare Dx o Sx

Desk with sliding tops and service unit H. 65 - Specify R or L  
 Bureau avec plateau coulissant et meuble de service Ht. 65 - Préciser D ou G  
 Mesa con sobres deslizantes y mueble auxiliar H. 65 - Indicar Dch o Izq

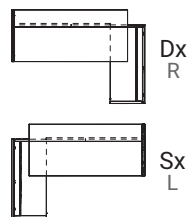
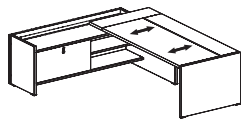

	L.P. T.L.	L. W.	P. D.	H. H.	CODICE CODE	M1	M3	Kg. lb	m <sup>3</sup> ft <sup>3</sup>	n. no.
FO	180 70 7/8"	210 82 5/8"	210 82 5/8"	75 29 1/2"	910TM3321			213,16 470.00	0,504 17.80	19 19
FO	200 78 3/4"	230 90 1/2"	210 82 5/8"	75 29 1/2"	910TM3323			217,66 480.00	0,521 18.40	19 19
FO	220 86 5/8"	250 98 3/8"	210 82 5/8"	75 29 1/2"	910TM3325			223,66 493.00	0,535 18.90	19 19

CANALE PASSACAVI  
 CABLE DUCT  
 PASSE-CÂBLES  
 CANAL PASACABLES



### Canale passacavi - Indicare Dx o Sx - Per scrivania con mobile di servizio - Abbinare canalina Dx con scrivania Sx - Abbinare canalina Sx con scrivania Dx

Cable duct - Specify R or L - For desk with service unit - Match R cable duct with L desk - Match L cable duct with R desk  
 Goulotte passe-câbles - Préciser D ou G - Pour bureau avec meuble de service - Commander la goulotte D avec bureau G - Commander la goulotte G avec bureau D  
 Canal pasacables - Indicar Dch o Izq - Para mesa con mueble auxiliar - Combinar canal Dch con la mesa Izq - Combinar canal Izq con la mesa Dch

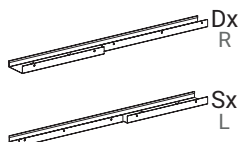

	L.P. T.L.	L. W.	P. D.	H. H.	CODICE CODE	PRICE	Kg. lb	m <sup>3</sup> ft <sup>3</sup>	n. no.
	180 70 7/8"	130 51 1/8"	15,4 6 1/8"	5,2 2"	910AP0114		3,80 8.38	0,014 0.49	1 1
	200 78 3/4"	150 59"	15,4 6 1/8"	5,2 2"	910AP0116		4,50 9.92	0,015 0.53	1 1
	220 86 5/8"	170 66 7/8"	15,4 6 1/8"	5,2 2"	910AP0118		5,00 11.00	0,017 0.60	1 1

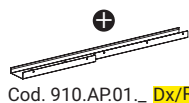
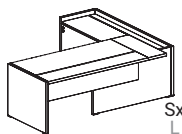

Cod. 910.AP.01.\_ Dx/R

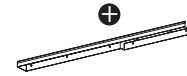
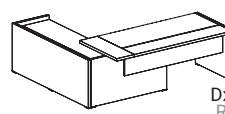

Cod. 910.AP.01.\_ Sx/L

DV913 VIGO  
 DV911 NOTO  
 DV905 RYM  
 DV901 VERTIGO  
 DV902 PLANETA  
 DV914 DAKAR  
 DV910 OXFORD

# DV910 - Oxford

**M1**  
PIANO OPERATORE + MODESTY  
USER-SIDE WORKTOP + MODESTY  
PLATEAU UTILISATEUR + VDF  
SOBRE LADO OPERADOR + FALDÓN



**M3**  
VARIANTE: PIANO OPERATORE + MODESTY  
VARIANT: WORKTOP + MODESTY  
VARIANTE: PLATEAU UTILISATEUR + VDF  
VARIANTE: SOBRE LADO OPERADOR + FALDÓN



+ PIANO VISITATORE + GAMBE  
VISITOR-SIDE WORKTOP + LEGS  
PLATEAU VISITEUR + PIEDS  
SOBRE VISITANTE + PATAS



+ COLONNA REG. ELETTRICA  
LIFTING COLUMN  
COLONNE RÉG. ÉLECTRIQUE  
COLUMN ELÉCTRICA REG.



## Scrivania regolabile elettricamente - Indicare tipo di alimentazione: EU / UK / US

Desk with electric height adjustment - Specify power supply: EU / UK / US

Bureau avec réglage en ht. électriquement - Indiquer le type d'alimentation électrique : EU / UK / US

Mesa eléctrica ajustable en altura - Indicar el tipo de alimentación: EU / UK / US

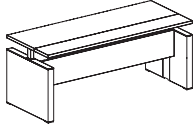

L. W.	P. D.	H. H.	CODICE CODE	M1 - EU/ UK	M1 - US	M3 - EU/ UK	M3 - US	Kg. lb	m <sup>3</sup> ft <sup>3</sup>	n. no.
180 70 7/8"	90 35 3/8"	75÷141 29 1/2÷55 1/2"	<b>910TS7018</b>					129,10 285.00	0,342 12.10	11 11
200 78 3/4"	90 35 3/8"	75÷141 29 1/2÷55 1/2"	<b>910TS7020</b>					136,40 301.00	0,365 12.90	11 11
220 86 5/8"	90 35 3/8"	75÷141 29 1/2÷55 1/2"	<b>910TS7022</b>					139,90 308.00	0,397 14.00	11 11

CANALE PASSACAVI  
CABLE DUCT  
PASSE-CÂBLES  
CANAL PASACABLES



## Canale passacavi singolo - Per scrivania

Single cable duct - For single desk

Goulotte simple passe-câbles - Pour bureau individuel

Canal pasacables individual - Para mesa individual



L.P. T.L.	L. W.	P. D.	H. H.	CODICE CODE	PRICE	Kg. lb	m <sup>3</sup> ft <sup>3</sup>	n. no.
180 70 7/8"	120 47 1/4"	10,2 4"	11,4 4 1/2"	<b>300AP2512</b>		2,00 4.41	0,007 0.25	1 1
200 78 3/4"	140 55 1/8"	10,2 4"	11,4 4 1/2"	<b>300AP2514</b>		2,20 4.85	0,009 0.32	1 1
220 86 5/8"	160 63"	10,2 4"	11,4 4 1/2"	<b>300AP2516</b>		2,50 5.51	0,010 0.35	1 1

CANALE PASSACAVI  
CABLE DUCT  
PASSE-CÂBLES  
CANAL PASACABLES



## Catena passacavi - Per tavoli con regolazione elettrica e mobile di servizio

Cable management chain - For desks with electric adjustment and service unit

Chaîne de gestion des câbles - Pour bureaux avec réglage électrique et meuble de service

Cadena pasacables - Para mesas ajustable eléctrica y mueble auxiliar



L. W.	P. D.	H. H.	CODICE CODE	PRICE	Kg. lb	m <sup>3</sup> ft <sup>3</sup>	n. no.
		132 52"	<b>818AP1013</b>		2,30 5.07	0,004 0.14	1 1

# DV910 - Oxford

## M1

PIANO OPERATORE + MODESTY + ANTE  
USER-SIDE WORKTOP + MODESTY + DOORS  
PLATEAU UTILISATEUR + VDF + PORTES  
SOBRE LADO OPERADOR + FALDÓN + PUERTAS



## M3

VARIANTE: PIANO OPERATORE + MODESTY + ANTE  
VARIANT: WORKTOP + MODESTY + DOORS  
VARIANTE: PLATEAU UTILISATEUR + VDF + PORTES  
VARIANTE: PIANO DEL USUARIO + FALDÓN + PUERTAS



+ PIANO VISITATORE + GAMBE + MOBILE SERVIZIO  
VISITOR-SIDE WORKTOP + LEGS + SERVICE UNIT  
PLATEAU VISITEUR + PIEDS + MEUBLE DE SERVICE  
SOBRE DEL VISITANTE + PATAS + MUEBLE AUXILIAR



+ COLONNA REG. ELETTRICA  
LIFTING COLUMN  
COLONNE RÉG. ÉLECTRIQUE  
COLUMN ELÉCTRICA REG.



### Scrivania regolabile elettricamente - Con mobile di servizio H. 65 - Indicare tipo di alimentazione: EU / UK / US - Indicare Dx o Sx

Desk with electric height adjustment - With service unit H. 65 - Specify power supply: EU / UK / US - Specify R or L

Bureau avec réglage en ht. électriquement - Avec meuble de service Ht. 65 - Indiquer le type d'alimentation électrique : EU / UK / US - Préciser D ou G

Mesa eléctrica ajustable en altura - Con mueble auxiliar H. 65 - Indicar el tipo de alimentación: EU / UK / US - Indicar Dch o Izq

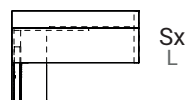
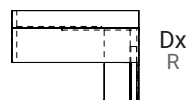
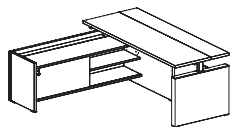

	L. W.	P. D.	H. H.	CODICE CODE	M1 - EU/ UK	M1 - US	M3 - EU/ UK	M3 - US	Kg. lb	m <sup>3</sup> ft <sup>3</sup>	n. no.
FD	180 70 7/8"	214 84 1/4"	75÷141 29 1/2÷55 1/2"	910TM3518					239,70 528.00	0,571 20.20	20 20
FD	200 78 3/4"	214 84 1/4"	75÷141 29 1/2÷55 1/2"	910TM3520					247,30 545.00	0,593 20.90	20 20
FD	220 86 5/8"	214 84 1/4"	75÷141 29 1/2÷55 1/2"	910TM3522					249,90 551.00	0,622 22.00	20 20

CANALE PASSACAVI  
CABLE DUCT  
PASSE-CÂBLES  
CANAL PASACABLES



### Canale passacavi singolo - Per scrivania

Single cable duct - For single desk

Goulotte simple passe-câbles - Pour bureau individuel

Canal pasacables individual - Para mesa individual



L.P. T.L.	L. W.	P. D.	H. H.	CODICE CODE	PRICE	Kg. lb	m <sup>3</sup> ft <sup>3</sup>	n. no.
180 70 7/8"	120 47 1/4"	10,2 4"	11,4 4 1/2"	300AP2512		2,00 4.41	0,007 0.25	1 1
200 78 3/4"	140 55 1/8"	10,2 4"	11,4 4 1/2"	300AP2514		2,20 4.85	0,009 0.32	1 1
220 86 5/8"	160 63"	10,2 4"	11,4 4 1/2"	300AP2516		2,50 5.51	0,010 0.35	1 1

CANALE PASSACAVI  
CABLE DUCT  
PASSE-CÂBLES  
CANAL PASACABLES



### Catena passacavi - Per tavoli con regolazione elettrica e mobile di servizio

Cable management chain - For desks with electric adjustment and service unit

Chaîne de gestion des câbles - Pour bureaux avec réglage électrique et meuble de service

Cadena pasacables - Para mesas ajustable eléctrica y mueble auxiliar



L. W.	P. D.	H. H.	CODICE CODE	PRICE	Kg. lb	m <sup>3</sup> ft <sup>3</sup>	n. no.
		132 52"	818AP1013		2,30 5.07	0,004 0.14	1 1

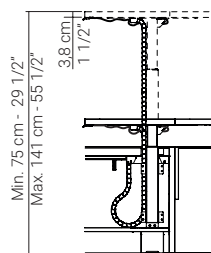
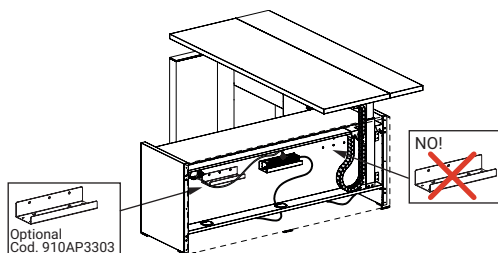

Optional  
Cod. 910AP3303

DV913 VIGO  
DV911 NOTO  
DV905 RYM  
DV901 VERTIGO  
DV902 PLANETA  
DV914 DAKAR  
DV910 OXFORD

CASSETTO IN METALLO  
METAL DRAWER  
TIROIR EN METAL  
CAJON METALICO



**Cassetto metallico - Per mobile di servizio - Con serratura**

Metal drawer - For service unit - With lock

Tiroir en métal - Pour meuble de service - Avec serrure

Cajonera metalica - Para mueble auxiliar - Con cerradura

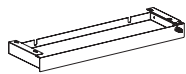

L. W.	P. D.	H. H.	CODICE CODE	PRICE	Kg. lb	m <sup>3</sup> ft <sup>3</sup>	n. no.
86 33 7/8"	31 12 1/4"	7 2 3/4"	<b>910CA0109</b>		4,70 10.40	0,023 0.81	1 1

PORTACARTELLE  
PULL-OUT FRAME  
PORTE-DOSSIERS  
PORTACARPETAS



**Portacartelle estraibile - Per mobile di servizio**

Pull-out frame holder - For service unit

Porte-dossiers extractible - Pour meuble de service

Portacarpetas extraíble - Para mueble auxiliar



L. W.	P. D.	H. H.	CODICE CODE	M1	Kg. lb	m <sup>3</sup> ft <sup>3</sup>	n. no.
90 35 3/8"			<b>910CSA508</b>		1,00 2.20	0,033 1.17	1 1

**Box per portacartelle cod. 910CSA508 - Optional**

Box for draw-out frame cod. 910CSA608 - Optional

Box pour porte-dossiers extractible cod. 910CSA508 - En option

Box para portacarpetas extraíble cod. 910CSA508 - Opcional



L. W.	P. D.	H. H.	CODICE CODE	PRICE	Kg. lb	m <sup>3</sup> ft <sup>3</sup>	n. no.
82 32 1/4"	34,5 13 5/8"	18 7 1/8"	<b>910CSA608</b>		4,10 9.04	0,013 0.46	1 1

**Vassoio per mobile di servizio - Optional**

Tray for service unit - Optional

Plateau de service pour meuble de service - En option

Bandeja para mueble auxiliar - Opcional

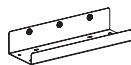

L. W.	P. D.	H. H.	CODICE CODE	PRICE	Kg. lb	m <sup>3</sup> ft <sup>3</sup>	n. no.
32 12 5/8"	10 3 7/8"		<b>910AP3303</b>		1,00 2.20	0,003 0.11	1 1

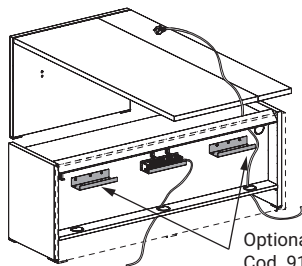

Optional  
Cod. 910AP3303

All'interno del vano tecnico del mobile di servizio è presente 1 vassoio di servizio / Inside the technical compartment of the service unit there is 1 tray / 1 plateau de service est prévu à l'intérieur du compartiment technique de la desserte / Dentro del compartimento técnico del mueble auxiliar hay 1 bandeja

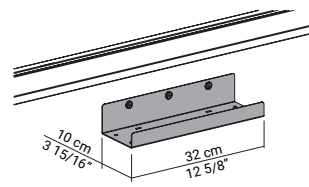



CASSETTO IN METALLO  
METAL DRAWER  
TIROIR EN METAL  
CAJON METALICO



**Cassetto sospeso in metallo - Per scrivania regolabile in altezza - Con serratura**

1 metal drawer hanging pedestal - For height-adjustable desk - With lock  
Tiroir suspendu en métal - Pour bureau réglable en hauteur - Avec serrure  
Cajonera colgante metalica - Para mesa regulable en altura - Con cerradura

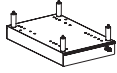

	L. W.	P. D.	H. H.	CODICE CODE	PRICE	Kg. lb	m <sup>3</sup> ft <sup>3</sup>	n. no.
FO	32,5 12 3/4"	52,5 20 5/8"	14,5 5 3/4"	910CA0105		4,30 9.48	0,013 0.46	2 2

**M1**  
PIANO  
WORKTOP  
PLATEAU  
SOBRE



**M3**  
PIANO  
WORKTOP  
PLATEAU  
SOBRE



+ GAMBE  
LEGS  
PIÈTEMENTS  
PATAS



**Penisola con gamba**

End meeting element with leg  
Elément terminal avec piètement  
Península con pata

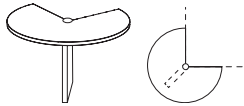

	L. W.	P. D.	H. H.	CODICE CODE	M1	M3	Kg. lb	m <sup>3</sup> ft <sup>3</sup>	n. no.
	120 47 1/4"	120 47 1/4"	75 29 1/2"	910PE0112			35,00 77.20	0,104 3.67	5 5

**M1**  
PIANO + ANTE  
WORKTOP + DOORS  
PLATEAU + PORTES  
SOBRE + PUERTAS



**M3**  
PIANO + ANTE  
WORKTOP + DOORS  
PLATEAU + PORTES  
SOBRE + PUERTAS



+ SCOCCA  
BODY  
STRUCTURE  
ESTRUCTURA



**Contenitore multifunzione - Indicare Dx o Sx**

Multi-purpose storage unit - Specify R or L  
Meuble multifonction - Préciser D ou G  
Mueble multiuso - Indicar Dch o Izq

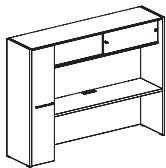

	L. W.	P. D.	H. H.	CODICE CODE	M1	M3	Kg. lb	m <sup>3</sup> ft <sup>3</sup>	n. no.
FO	250 98 3/8"	60 23 5/8"	190 74 3/4"	910HC0125			229,08 505.00	0,708 25.00	13 13

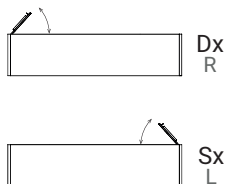

All'interno dell'anta è posizionato uno specchio L= 30 cm H=70 cm / A mirror L= 30 cm - 11 7/8" H=70 cm - 27 9/16" is positioned inside the hinged door / Un miroir L = 30 cm H = 70 cm est prévu à l'intérieur de la porte / En el interior de la puerta batiente se coloca un espejo L= 30 cm H= 70 cm

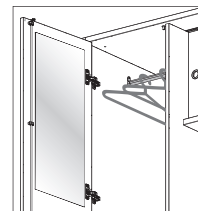

Il contenitore è dotato di un tubo appendiabiti / A clothes rail is included in the storage unit / Dans l'armoire est inclus un tube porte-manteux / El mueble incluye un perchero

# DV910 - Oxford

**M1**  
PIANO + ANTE  
WORKTOP + DOORS  
PLATEAU + PORTES  
SOBRE + PUERTAS



**M3**  
PIANO + ANTE + PIANO UTILIZ. + MODESTY  
WORKTOP + DOORS + USER-SIDE TOP + MODESTY  
PLATEAU + PORTES + PLAT. UTILIS. + VDF  
SOBRE + PUERTAS + SOBRE USUARIO + FALDÓN



**+** SCOCCA  
BODY  
STRUCTURE  
ESTRUCTURA



## Composizione con scrivania e contenitore multifunzione - Indicare Dx o Sx

Composition with desk and multi-purpose storage unit - Specify R or L

Composition avec bureau et meuble multifonction - Préciser D ou G

Composición con mesa y mueble multiuso - Indicar Dch o Izq

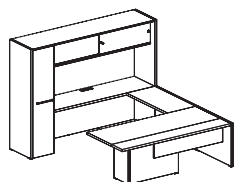

L.P. T.L.	L. W.	P. D.	H. H.	CODICE CODE	M1	M3	Kg. lb	m <sup>3</sup> ft <sup>3</sup>	n. no.
200 78 3/4"	250 98 3/8"	266 104 3/4"	190 74 3/4"	<b>910CMP220</b>			374,68 826.00	1,042 36.80	25 25
220 86 5/8"	250 98 3/8"	266 104 3/4"	190 74 3/4"	<b>910CMP222</b>			380,68 839.00	1,052 37.20	25 25

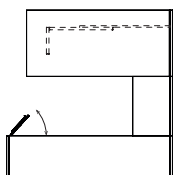

Dx  
R

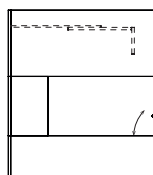

Sx  
L

CASSETTO IN METALLO  
METAL DRAWER  
TIROIR EN METAL  
CAJON METALICO



## Cassetto sospeso in metallo - Con serratura - Per scrivania H 75 cm - Per contenitore multifunzione

1 metal drawer hanging pedestal - With lock - For desk H 75 cm - For multi-purpose storage unit

Tiroir suspendu en métal - Avec serrure - Pour bureau H 75 cm - Pour meuble multifonction

Cajonera colgante metalica - Con cerradura - Para mesa H 75 cm - Para mueble multiuso



L. W.	P. D.	H. H.	CODICE CODE	PRICE	Kg. lb	m <sup>3</sup> ft <sup>3</sup>	n. no.
32,5 12 3/4"	52,5 20 5/8"	7,2 2 7/8"	<b>910CA0104</b>		4,00 8.82	0,012 0.42	1 1

**N.B.: Non è possibile posizionare il cassetto sottopiano sull'allungo collegato al contenitore multifunzione e alla scrivania** / Note: It is not possible to place the drawer under the worktop on the extension side when it is connected to the multifunctional storage unit and the desk / N.B.: Il n'est pas possible de placer le tiroir sous plateau dans le retour si le retour est branché au rangement multifonctionnel et au bureau / N.B.: No es posible colocar el cajón debajo el sobre de trabajo de la ala auxiliar cuando está conectado al contenedor multifunción y a la mesa

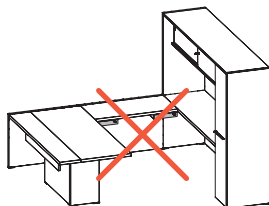

**N.B.: Non è possibile abbinare il cassetto sottopiano ai tavoli sliding** / Note: It is not possible to place the drawer under the worktop on the desk with sliding tops / N.B.: Il n'est pas possible de placer le tiroir sous plateau dans le bureaux avec plateaux coulissants / N.B.: No es posible colocar el cajón debajo el sobre de trabajo de la mesa con sobres sliding

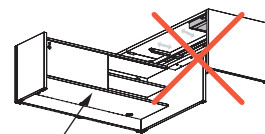

Cod. 910TM3323  
Cod. 910TM3325

# DV910 - Oxford

**M1**  
FRONTALI CASSETTI  
DRAWER FRONTS  
FAÇADES DE TIROIRS  
FRENTE DE CAJÓN



**M3**  
FRONTALI CASSETTI  
DRAWER FRONTS  
FAÇADES DE TIROIRS  
FRENTE DE CAJÓN



**+** FIANCO DI FINITURA  
FINISHING SIDE PANEL  
CÔTÉ DE FINITION  
LATERAL DE ACABADO



## Cassettiera portante - 1 cassetto + 1 classificatore - Per contenitore multifunzione

Carrying pedestal - 1 drawer + 1 filing drawer - For multi-purpose storage unit  
Caisson ht bureau - 1 tiroir + 1 pour dossiers suspendus - Pour meuble multifonction  
Cajonera portante - 1 cajón + 1 archivador - Para mueble multiuso

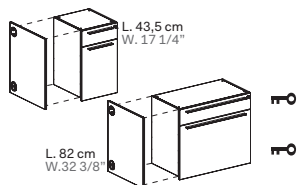

	L. W.	P. D.	H. H.	CODICE CODE	M1	M3	Kg. lb	m <sup>3</sup> ft <sup>3</sup>	n. no.
FO	43,5 17 1/8"	58 22 7/8"	71 28"	910EC0104			32,66 72.00	0,198 6.99	6 6
FO	82 32 1/4"	58 22 7/8"	71 28"	910EC0108			52,24 115.00	0,320 11.30	6 6

## Cassettiera portante - 4 cassetti in melaminico rivestiti in PVC - Per contenitore multifunzione

Carrying pedestal - 4 PVC-coated melamine drawers - For multi-purpose storage unit  
Caisson ht bureau - 4 tiroirs en mélamine revêtus de PVC - Pour meuble multifonction  
Cajonera portante - 4 cajones de melamina revestidos en PVC - Para mueble multiuso

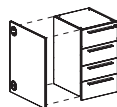

	L. W.	P. D.	H. H.	CODICE CODE	M1	M3	Kg. lb	m <sup>3</sup> ft <sup>3</sup>	n. no.
FO	43,5 17 1/8"	58 22 7/8"	71 28"	910EC0204			32,82 72.40	0,200 7.06	8 8

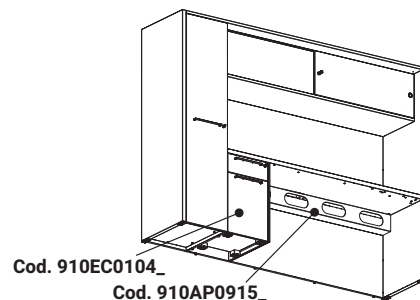
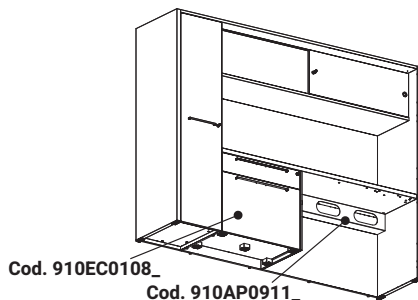
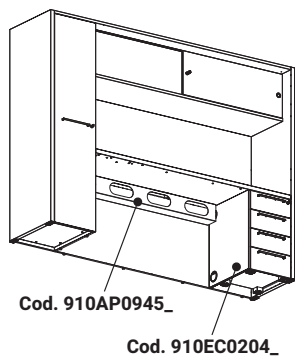

## Cassettiera portante - 1 cassetto + 1 classificatore - Per allungo

Carrying pedestal - 1 drawer + 1 filing drawer - For return  
Caisson ht bureau - 1 tiroir + 1 pour dossiers suspendus - Pour retour  
Cajonera portante - 1 cajón + 1 archivador - Para alargado

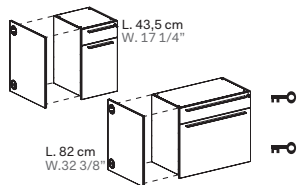

	L. W.	P. D.	H. H.	CODICE CODE	M1	M3	Kg. lb	m <sup>3</sup> ft <sup>3</sup>	n. no.
FO	43,5 17 1/8"	56 22"	71 28"	910EC0304			32,66 72.00	0,198 6.99	6 6
FO	82 32 1/4"	56 22"	71 28"	910EC0308			52,24 115.00	0,320 11.30	6 6

# DV910 - Oxford

**M1**  
FRONTALI CASSETTI  
DRAWER FRONTS  
FAÇADES DE TIROIRS  
FRENTE DE CAJÓN



**M3**  
FRONTALI CASSETTI  
DRAWER FRONTS  
FAÇADES DE TIROIRS  
FRENTE DE CAJÓN



**+** FIANCO DI FINITURA  
FINISHING SIDE PANEL  
CÔTÉ DE FINITION  
LATERAL DE ACABADO



## Cassettiera portante - 4 cassetti in melaminico rivestiti in PVC - Per allungo

Carrying pedestal - 4 PVC-coated melamine drawers - For return

Caisson ht bureau - 4 tiroirs en mélamine revêtus de PVC - Pour retour

Cajonera portante - 4 cajones de melamina revestidos en PVC - Para alargo

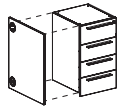

	L. W.	P. D.	H. H.	CODICE CODE	M1	M3	Kg. lb	m <sup>3</sup> ft <sup>3</sup>	n. no.
<b>P</b>	43,5 17 1/8"	56 22"	71 28"	<b>910EC0404</b>			32,82 72.40	0,200 7.06	8 8

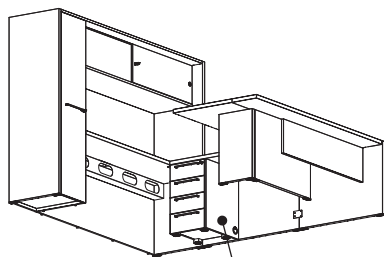

Cod. 910EC0404\_

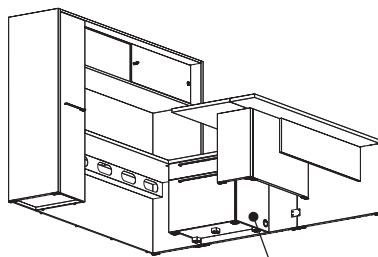

Cod. 910EC0308\_

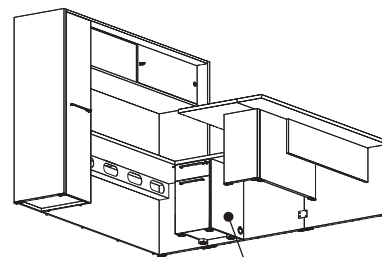

Cod. 910EC0304\_

SCHIENA PUNTINABILE  
PINNABLE BACK PANEL  
PANNEAU PUNAISABLE  
TRASERA PINNABLE



## Schiena puntinabile - Per contenitore multifunzione

Pinnable back panel - For multi-purpose storage unit

Panneau punaisable - Pour meuble multifonction

Trasera pinnable - Para mueble multiuso

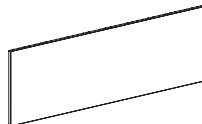

	L. W.	P. D.	H. H.	CODICE CODE	PRICE	Kg. lb	m <sup>3</sup> ft <sup>3</sup>	n. no.
	200 78 3/4"	2,5 1"	69,5 27 3/8"	<b>910ACSC20</b>		6,00 13.20	0,055 1.94	1 1

## Barra led - Per contenitore multifunzione - Indicare tipo di alimentazione: EU / UK / US

LED spotlight bar - For multi-purpose storage unit - Specify power supply: EU / UK / US

Spot LED - Pour meuble multifonction - Indiquer le type d'alimentation électrique : EU / UK / US

Barra de iluminación led - Para mueble multiuso - Indicar el tipo de alimentación: EU / UK / US

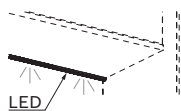

	L. W.	P. D.	H. H.	CODICE CODE	EU/UK	US	Kg. lb	m <sup>3</sup> ft <sup>3</sup>	n. no.
<b>P</b>	200 78 3/4"	3 1 1/8"	1,5 5/8"	<b>910LL0220</b>			6,50 14.30	0,018 0.64	2 2

CANALE PASSACAVI  
CABLE DUCT  
PASSE-CÂBLES  
CANAL PASACABLES



**Canale passacavi - Per contenitore multifunzione - L. 116,5**

Cable duct - For multi-purpose storage unit - W. 116,5  
Goulotte passe-câbles - Pour meuble multifonction - L. 116,5  
Canal pasacables - Para mueble multiuso - L. 116,5

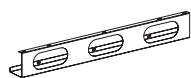

L. W.	P. D.	H. H.	CODICE CODE	PRICE	Kg. lb	m <sup>3</sup> ft <sup>3</sup>	n. no.
116,5 45 7/8"	12 4 3/4"	15 5 7/8"	910AP0911		4,00 8.82	0,025 0.88	1 1

**Canale passacavi - Per contenitore multifunzione - L. 155**

Cable duct - For multi-purpose storage unit - W. 155  
Goulotte passe-câbles - Pour meuble multifonction - L. 155  
Canal pasacables - Para mueble multiuso - L. 155

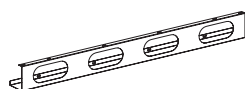

L. W.	P. D.	H. H.	CODICE CODE	PRICE	Kg. lb	m <sup>3</sup> ft <sup>3</sup>	n. no.
155 61"	12 4 3/4"	15 5 7/8"	910AP0915		5,00 11.00	0,033 1.17	1 1

**Canale passacavi - Per contenitore multifunzione - L. 199**

Cable duct - For multi-purpose storage unit - W. 199  
Goulotte passe-câbles - Pour meuble multifonction - L. 199  
Canal pasacables - Para mueble multiuso - L. 199

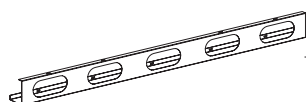

L. W.	P. D.	H. H.	CODICE CODE	PRICE	Kg. lb	m <sup>3</sup> ft <sup>3</sup>	n. no.
199 78 3/8"	12 4 3/4"	15 5 7/8"	910AP0919		6,50 14.30	0,040 1.41	1 1

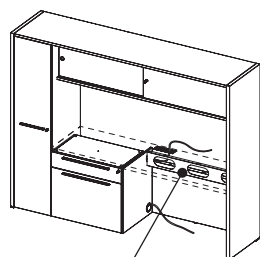

Cod. 910.AP.09.11

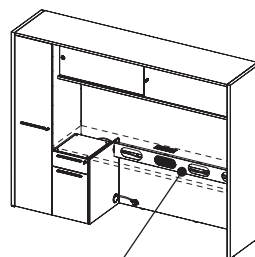

Cod. 910.AP.09.15

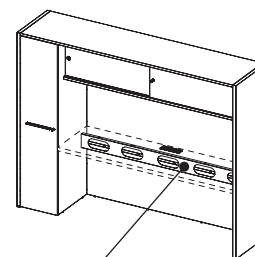

Cod. 910.AP.09.19

**Canale passacavi verticale**

Vertical cable duct  
Passe-câbles vertical  
Canal pasacables vertical



L. W.	P. D.	H. H.	CODICE CODE	PRICE	Kg. lb	m <sup>3</sup> ft <sup>3</sup>	n. no.
		58 22 7/8"	910AP0806		1,00 2.20	0,003 0.11	1 1

# DV910 - Oxford

**M1**  
PIANO  
WORKTOP  
PLATEAU  
SOBRE



**M3**  
PIANO  
WORKTOP  
PLATEAU  
SOBRE



+

**GAMBE**  
LEGS  
PIÈTEMENTS  
PATAS



## Tavolo riunioni - L. 140

Meeting table - W. 140  
Table de réunion - L. 140  
Mesa de reunión - L. 140

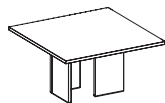

L. W.	P. D.	H. H.	CODICE CODE	M1	M3	Kg. lb	m <sup>3</sup> ft <sup>3</sup>	n. no.
140 55 1/8"	140 55 1/8"	75 29 1/2"	<b>910TR3814</b>			89,00 196.00	0,199 7.03	3 3

## Tavolo riunioni - L. 240

Meeting table - W. 240  
Table de réunion - L. 240  
Mesa de reunión - L. 240

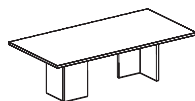

L. W.	P. D.	H. H.	CODICE CODE	M1	M3	Kg. lb	m <sup>3</sup> ft <sup>3</sup>	n. no.
240 94 1/2"	120 47 1/4"	75 29 1/2"	<b>910TR4124</b>			111,00 245.00	0,250 8.83	3 3

## Tavolino caffè

Coffee table  
Table basse  
Mesa de café

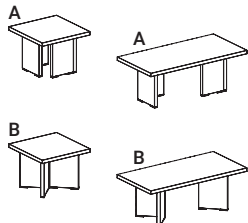

L. W.	P. D.	H. H.	CODICE CODE	M1	M3	Kg. lb	m <sup>3</sup> ft <sup>3</sup>	n. no.
60 23 5/8"	60 23 5/8"	45 17 3/4"	<b>910TT0306</b>			24,00 52.90	0,047 1.66	2 2
120 47 1/4"	60 23 5/8"	45 17 3/4"	<b>910TT0312</b>			34,00 75.00	0,067 2.37	2 2

**A**  
Con gambe a "L"  
With "L" shaped legs  
Avec pied en forme de "L"  
Con patas a "L"

**B**  
Con gambe a "V"  
With "V" shaped legs  
Avec pied en forme de "V"  
Con patas a "V"